

102mm/4.02"

DOGLEG SPAN
Max. 50mm/2.0"
Min. 10mm/0.4"

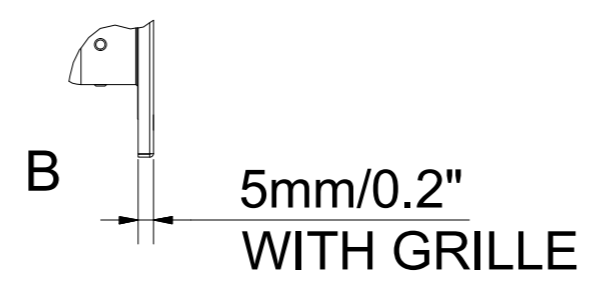

5mm/0.2"
WITH GRILLE

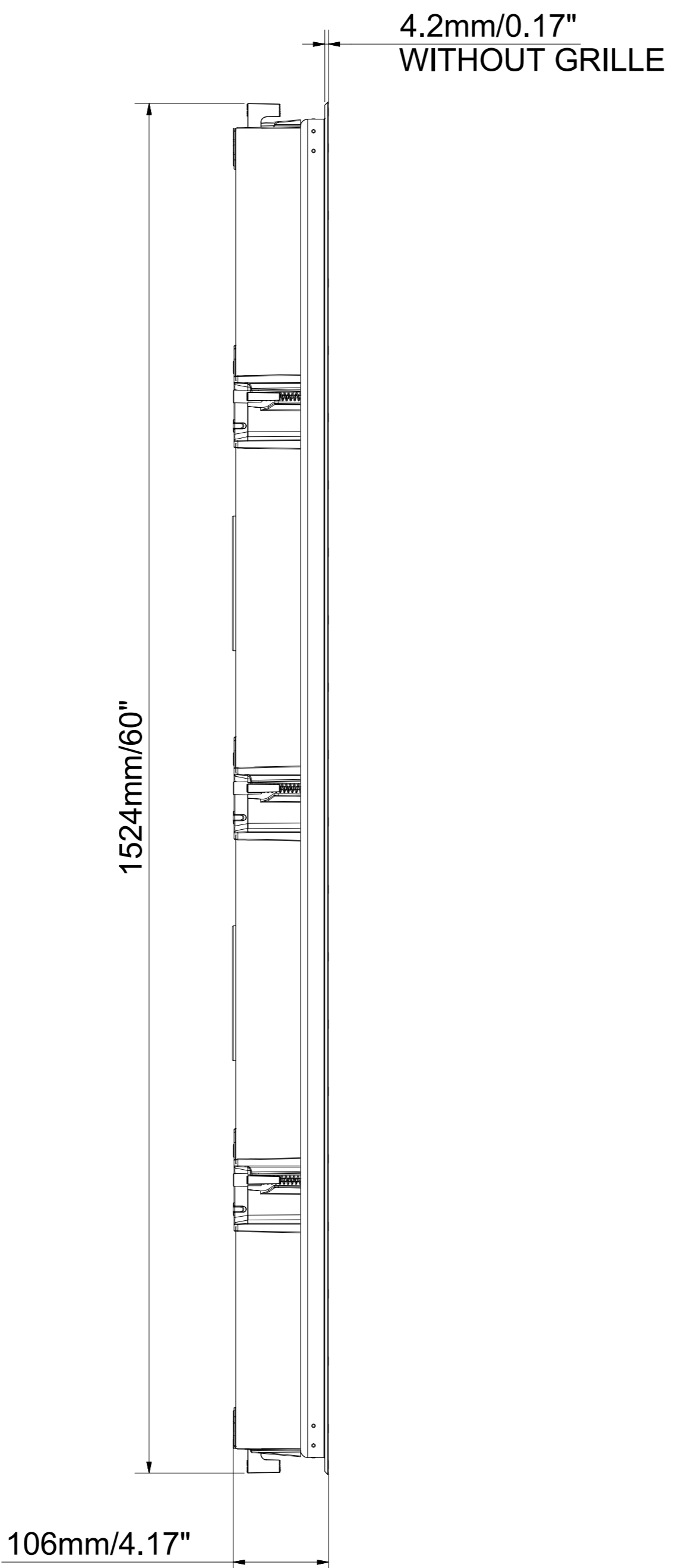

106mm/4.17"

4.2mm/0.17"
WITHOUT GRILLE

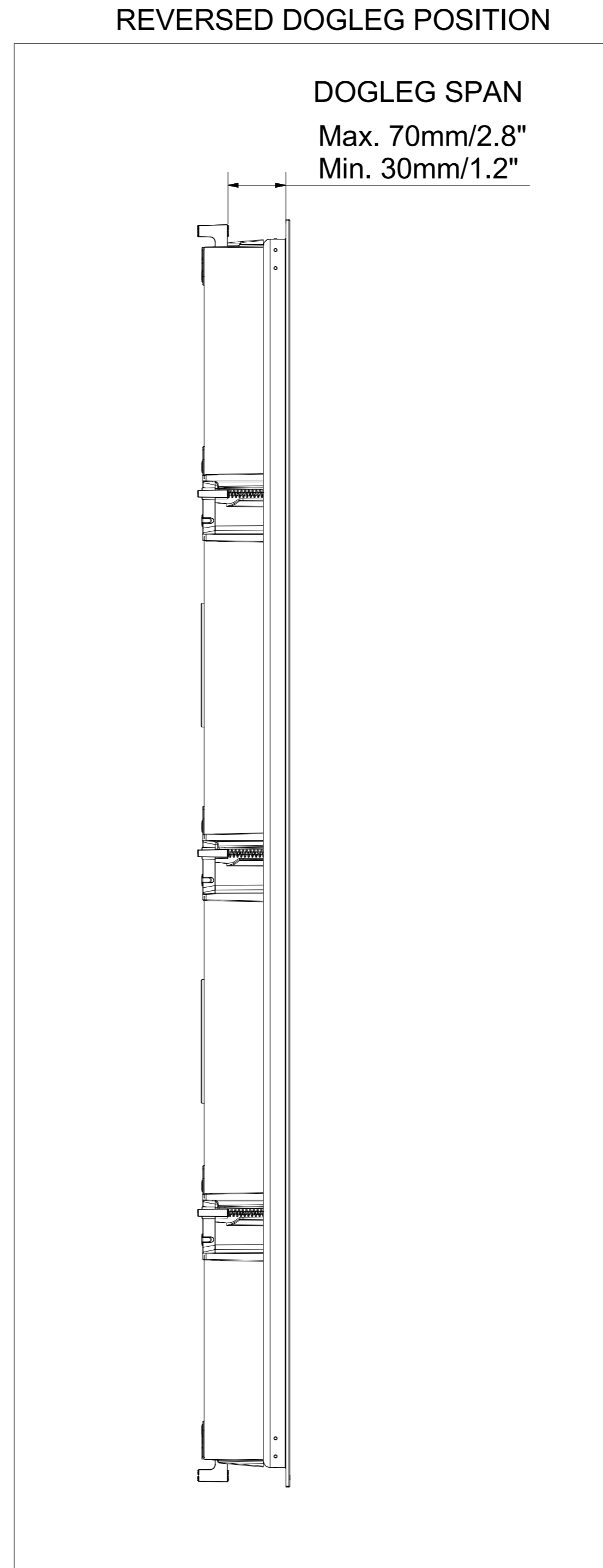

DOGLEG SPAN
Max. 70mm/2.8"
Min. 30mm/1.2"

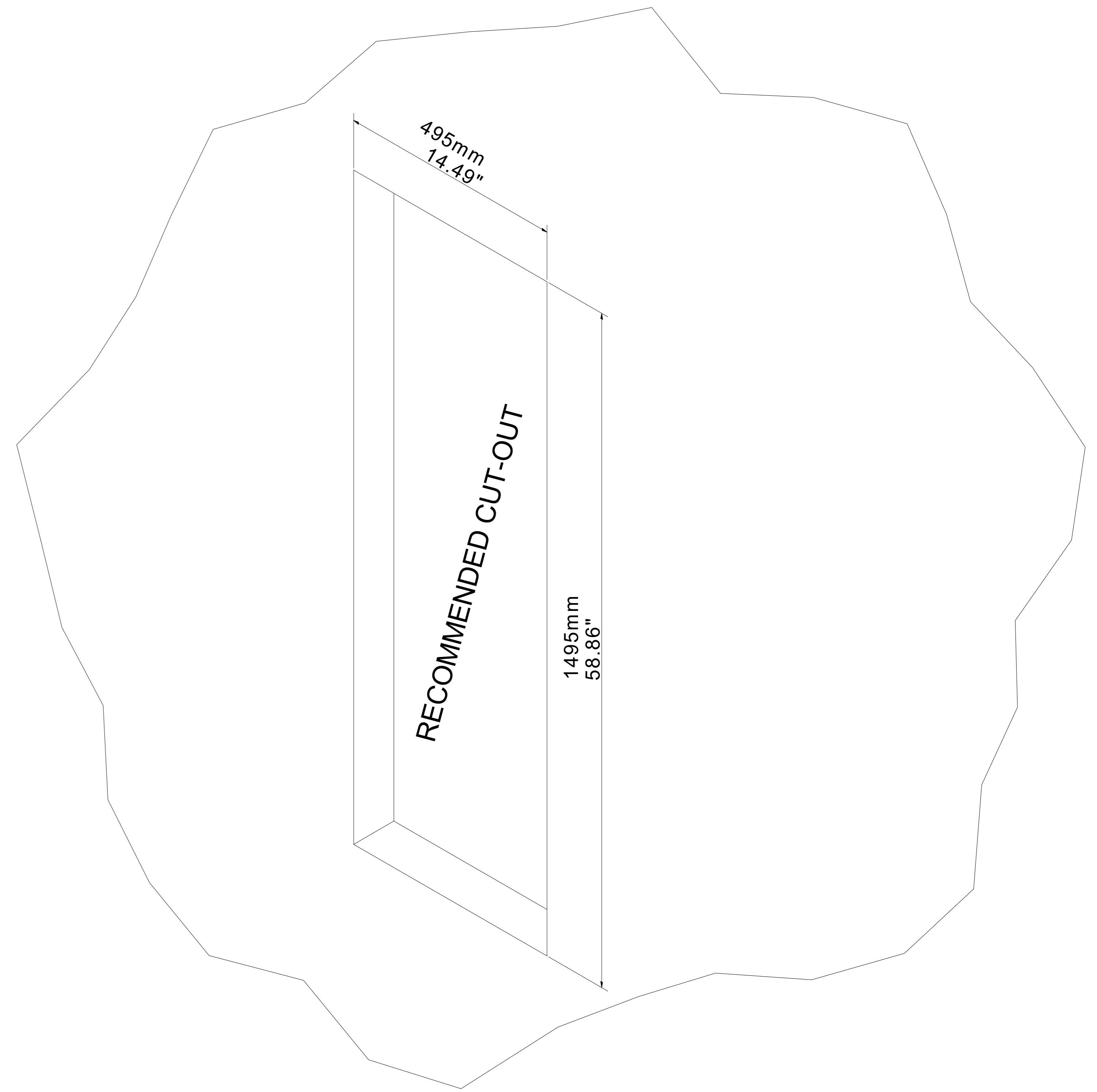
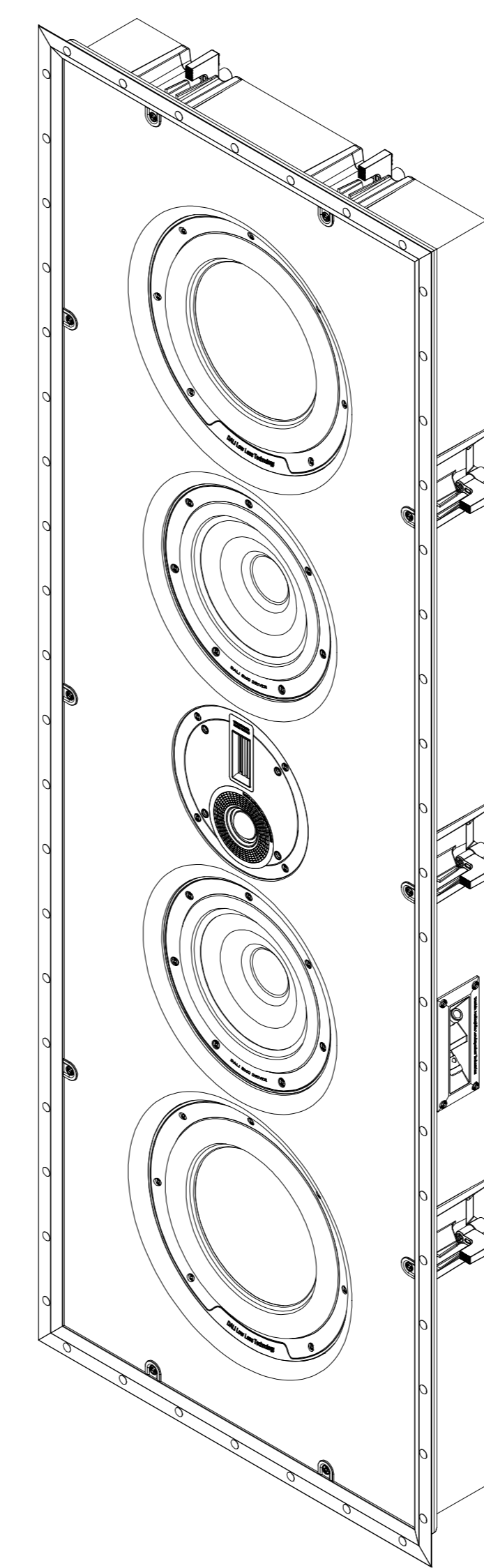
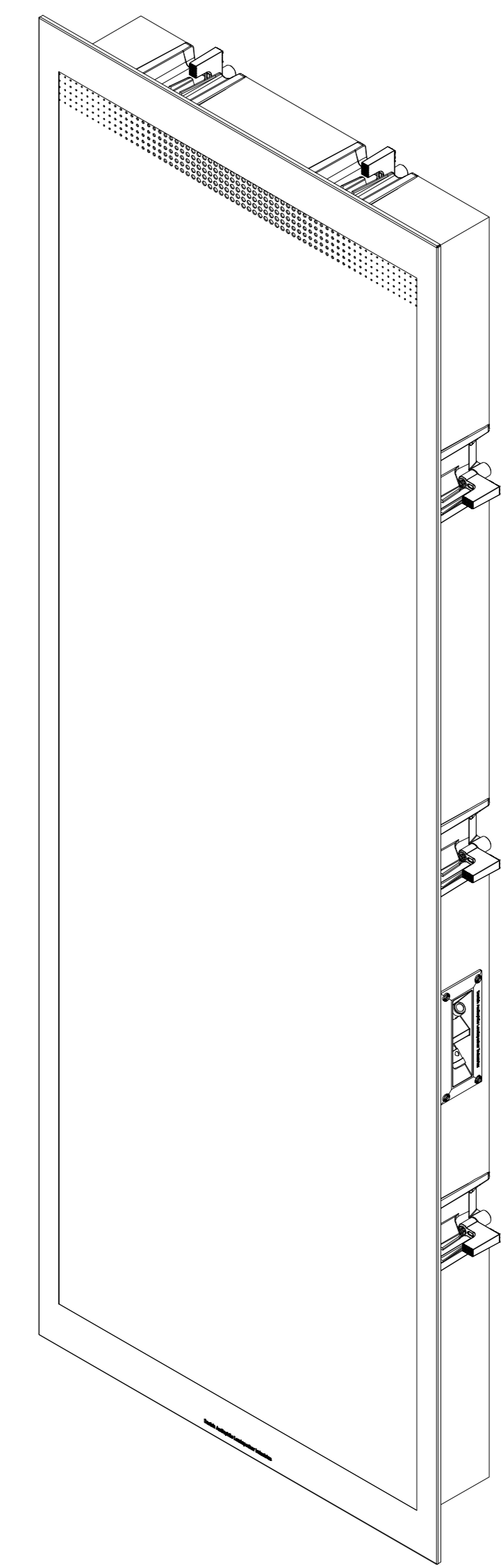

RECOMMENDED CUT-OUT

1495mm
58.86"

WEIGHT: 38KG

Material:	From mm:	0.5	3	6	30	120	400	1000
Drawn by:	To mm (inch):	1	6	30	120	400	1000	2000
Created:	Scale:	0.05	0.05	0.1	0.15	0.2	0.3	0.5
24-11-2016		0.1	0.1	0.2	0.3	0.5	0.8	1.2
Part no:	Sheet:	1	2	3	4	5	6	7
262082 PHANTOM S-280	1	2	3	4	5	6	7	8
Drawing no:	Form:	AD						
262082 PHANTOM S-280 Outer Dimension								



REV	DATE	ENGINEER	APPROVED	DESCRIPTION	ECO
1	24-11-2016	DRO			

B

B

A

A

Title:	Revision sheet	Sheet:	2 / 2	 DALI A/S Dali Allé 1 DK-9610 Nørager, Denmark Tel. +45 9672 1155 Fax +45 9855 1940
Drawing no.:	262082 PHANTOM S-280 Outer Dimension	Format:	A4	

4

3

2

1